

a
e
i
o
u



a
e
i
o
u



ca**s**a



a
e
i
o
u



a
e
i
o
u



tesouro



a
e
i
o
u



a
e
i
o
u



ca**sa**

a
e
i
o
u



a
e
i
o
u



ca**sa**

a
e
i
o
u



a
e
i
o
u



ca**sa**

a
e
i
o
u



a
e
i
o
u



ca**sa**

a
e
i
o
u



a
e
i
o
u



ca**sa**

a
e
i
o
u



a
e
i
o
u



ca**sa**

a
e
i
o
u



a
e
i
o
u



ca**sa**

a
e
i
o
u



a
e
i
o
u



ca**sa**

a
e
i
o
u



a
e
i
o
u



ca**sa**

a
e
i
o
u

S

a
e
i
o
u



tesouro

a
e
i
o
u

S

a
e
i
o
u



tesouro

a
e
i
o
u

S

a
e
i
o
u



tesouro

a
e
i
o
u

S

a
e
i
o
u



tesouro

a
e
i
o
u

S

a
e
i
o
u



tesouro

a
e
i
o
u

S

a
e
i
o
u



tesouro

a
e
i
o
u

S

a
e
i
o
u



tesouro

a
e
i
o
u

S

a
e
i
o
u



tesouro

a
e
i
o
u

S

a
e
i
o
u



tesouro

a
l
i
o
u



a
l
i
o
u

raposa



a
l
i
o
u



a
l
i
o
u

raposa



a
l
i
o
u



a
l
i
o
u

raposa



a
l
i
o
u



a
l
i
o
u

raposa



a
l
i
o
u



a
l
i
o
u

raposa



a
l
i
o
u



a
l
i
o
u

raposa



a
l
i
o
u



a
l
i
o
u

raposa



a
l
i
o
u



a
l
i
o
u

raposa



a
l
i
o
u



a
l
i
o
u

raposa



a
l
i
o
u



a
l
i
o
u

raposa



a
l
i
o
u



a
l
i
o
u

raposa



a
l
i
o
u



a
l
i
o
u

raposa



a
l
i
o
u



a
l
i
o
u

raposa



a
l
i
o
u



a
l
i
o
u

raposa



a
l
i
o
u



a
l
i
o
u

raposa





a
l
l
o
u



a
l
l
o
u

José



a
l
l
o
u



a
l
l
o
u

José

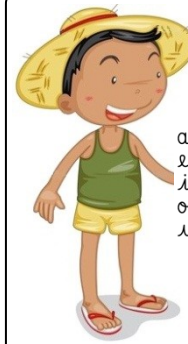

a
l
l
o
u



a
l
l
o
u

José



a
l
l
o
u



a
l
l
o
u

José

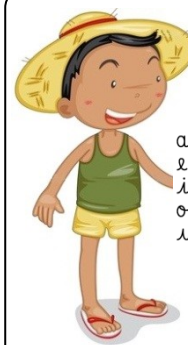

a
l
l
o
u



a
l
l
o
u

José



a
l
l
o
u



a
l
l
o
u

José



a
l
l
o
u



a
l
l
o
u

José



a
l
l
o
u



a
l
l
o
u

José



a
l
l
o
u



a
l
l
o
u

José



a
l
l
o
u



a
l
l
o
u

José



a
l
l
o
u



a
l
l
o
u

José



a
l
l
o
u



a
l
l
o
u

José



a
l
l
o
u



a
l
l
o
u

José

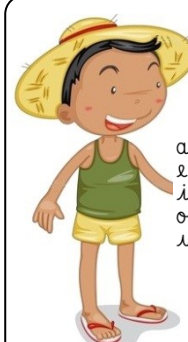

a
l
l
o
u



a
l
l
o
u

José



a
l
l
o
u



a
l
l
o
u

José



casaco

roseira

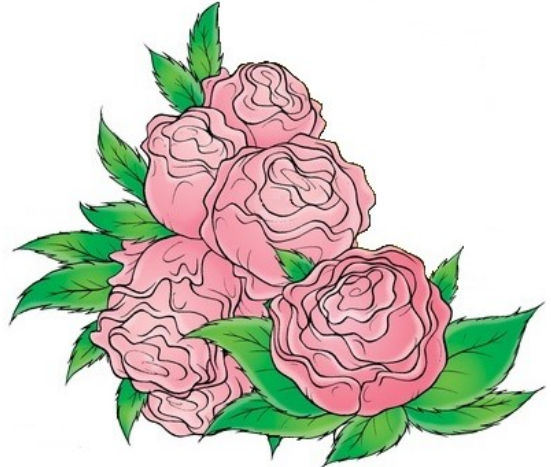

música

casota



casulo



a
l
i
o
u



a
l
i
o
u



rosa

casaco

raposa

mesa

asa

casota

vaso

riso

casa

camisa

tesoura

roseira

casulo

parafuso

televisão

a
l
i
o
u

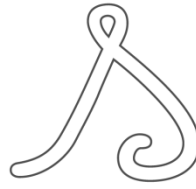

a
l
i
o
u



rosa

casaco

raposa

mesa

asa

casota

vaso

riso

casa

camisa

tesoura

roseira

casulo

parafuso

televisão

a
l
i
o
u



a
l
i
o
u



rosa

casaco

raposa

mesa

asa

casota

vaso

riso

casa

camisa

tesoura

roseira

casulo

parafuso

televisão

a
l
i
o
u



a
l
i
o
u



rosa

casaco

raposa

mesa

asa

casota

vaso

riso

casa

camisa

tesoura

roseira

casulo

parafuso

televisão

1º
ANO

PORTUGUÊS

RUBRICA :

Nome : _____

INFORMAÇÃO :

Data : __/__/__



Pinta e recorta as imagens e as palavras.
Cola-as correctamente na folha anterior.

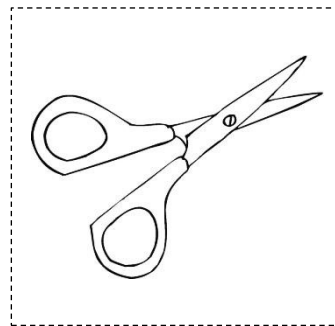
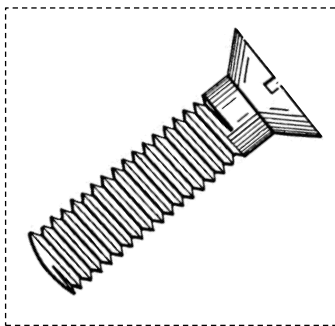
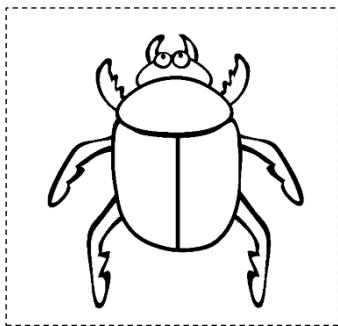
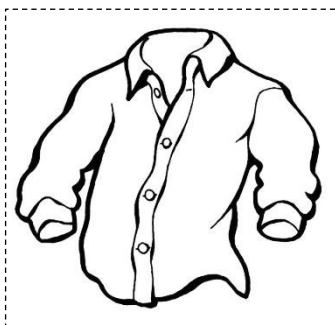
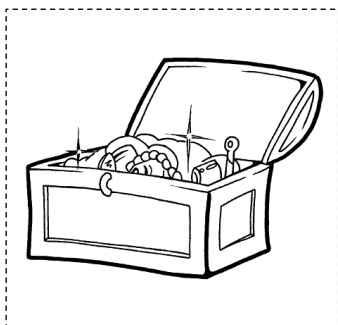
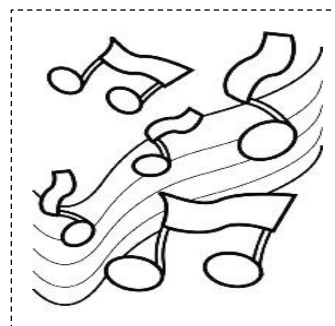
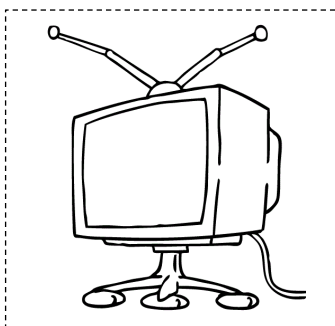
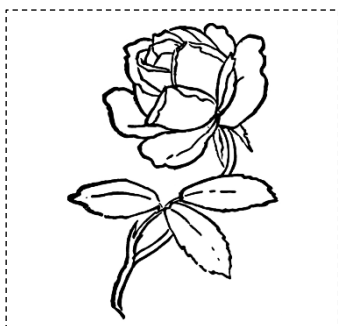
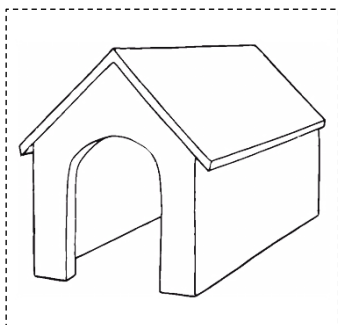

mesa

raposa

besouro

televisão

rosa

camisa

casota

música

casa

tesoura

tesouro

parafuso

Nome : _____

INFORMAÇÃO : _____

Data : ___/___/___



Completa o puzzle colando os desenhos da página seguinte. Pinta a teu gosto.

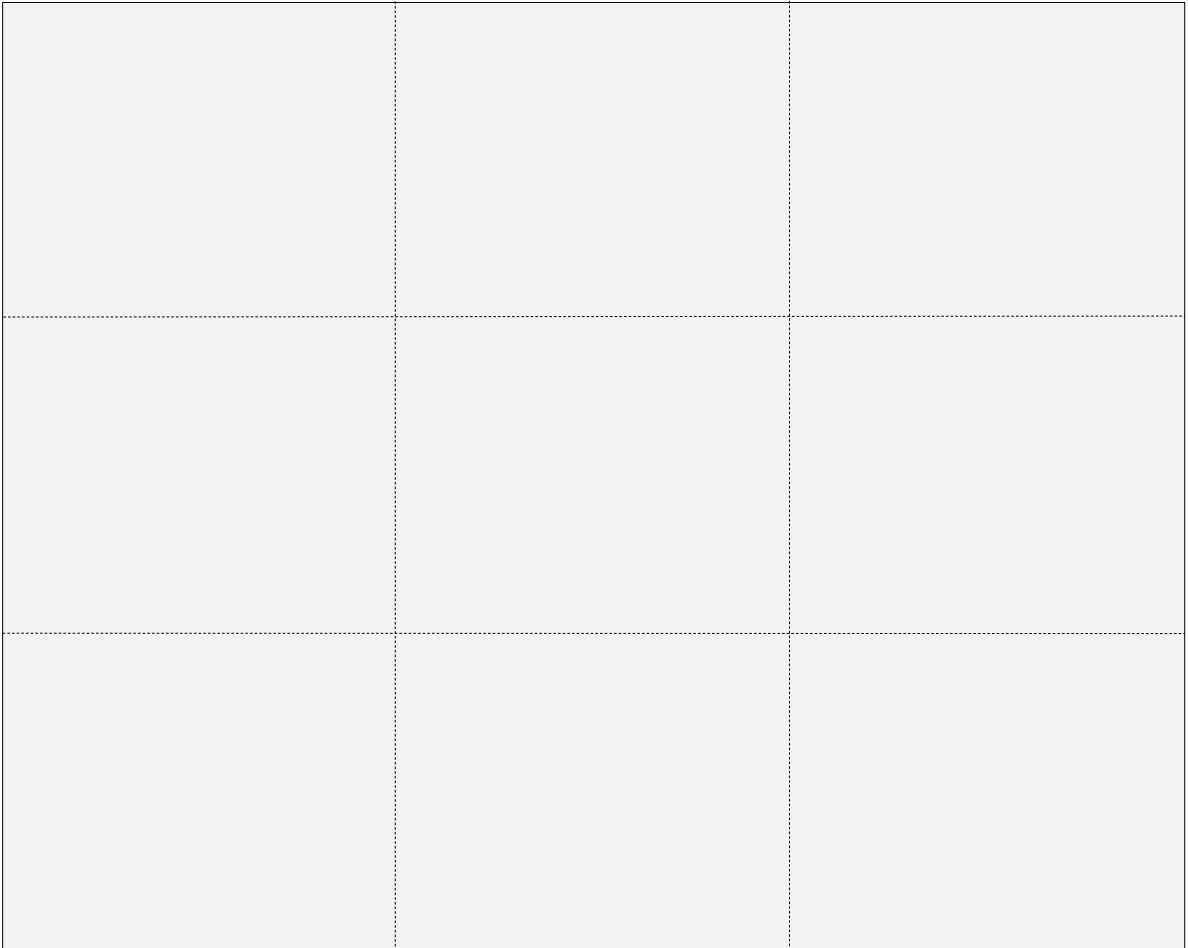



Recorta as peças do puzzle e cola-as correctamente na página anterior.

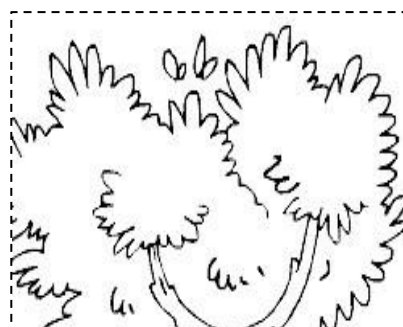
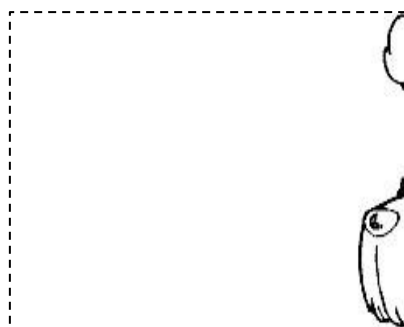
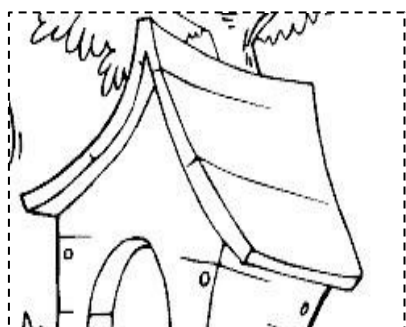
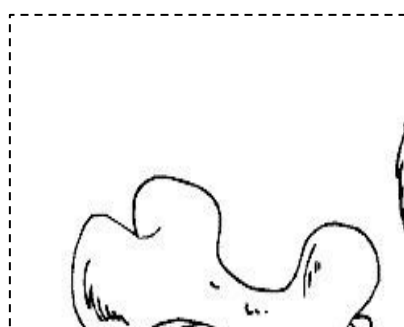
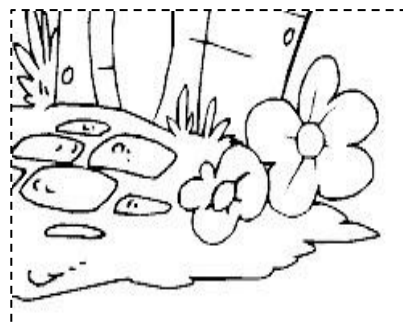
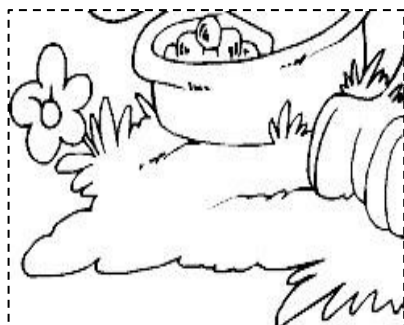

Nome : _____

INFORMAÇÃO : _____

Data : ___/___/___



Completa o puzzle colando os desenhos da página seguinte. Pinta a teu gosto.

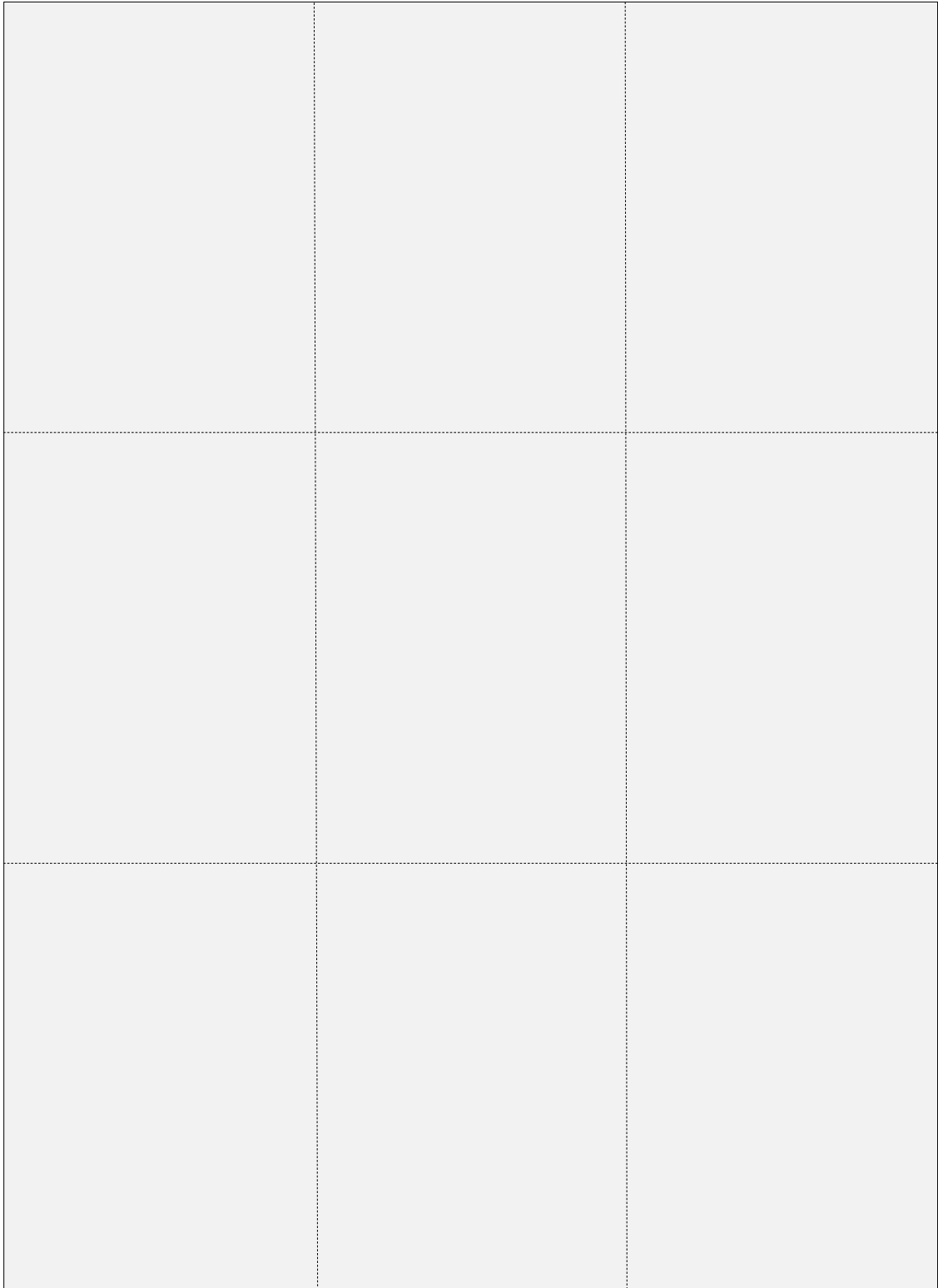
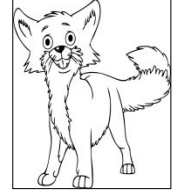



Recorta as peças do puzzle e cola-as correctamente na página anterior.

