

Nome : _____

INFORMAÇÃO : _____

Data : ___/___/___



Eu sou a letra que se lê **sa, se, si, so, su**. Completa.



sa se si so su



Sa Se Si So Su

Nome : _____

INFORMAÇÃO : _____

Data : ____ / ____ / ____



sino

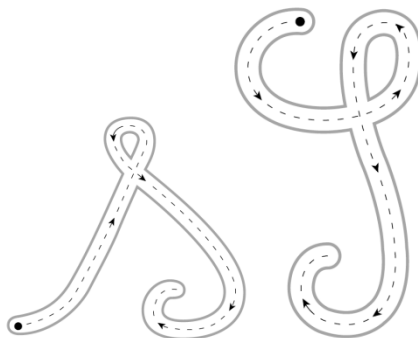

Continua a letra **s**.



Completa as palavras com a sílaba correcta.

- sa
- se
- si
- so
- su



___ pato

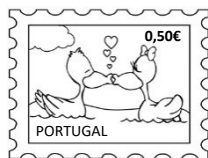

___ lo



___ pa

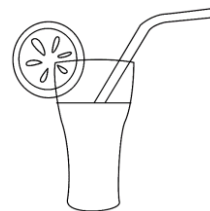

___ mo

Forma palavras e copia.

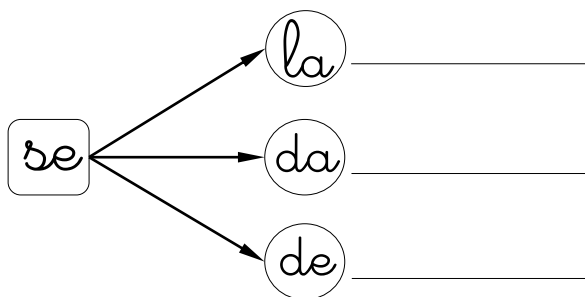
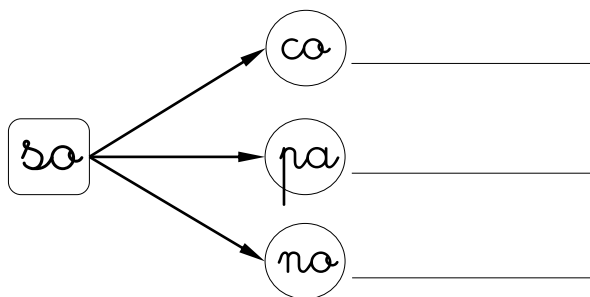

Forma frases.

sapo ► _____

sapato ► _____

Nome : _____

INFORMAÇÃO :

Data : ____ / ____ / ____

 Assinala.

sa se so su pa to mo lo co



sapato

X

X

X



sopa



sumo



selo



saco

	sa	se	so	su	pa	to	mo	lo	co
sapato	X				X	X			
sopa									
sumo									
selo									
saco									

 Ordena as palavras e copia.

 Ilustra uma das frases.

lava saia. A Sónia a

o Rita sumo. bebe A



 Separa as sílabas das palavras, conforme o exemplo.



sapato

sa – pa – to



saco



satélite



sumo



salada



sineta

Nome : _____

INFORMAÇÃO : _____

Data : ____ / ____ / ____

 Junta as sílabas e forma palavras.

sa	pa-to ▶ _____	si	ne-ta ▶ _____
	la-da ▶ _____		na ▶ _____
	té-li-te ▶ _____		ni-to ▶ _____
so	li-dão ▶ _____	se	te ▶ _____
	ne-ca ▶ _____		lo ▶ _____
	le-ne ▶ _____		ma-na ▶ _____

 Escreve uma frase com as palavras.

A Salomé a toda. sopa comeu

 Pinta as figuras em cujos nomes ouves **s**.



Nome : _____

INFORMAÇÃO :

Data : ____ / ____ / ____

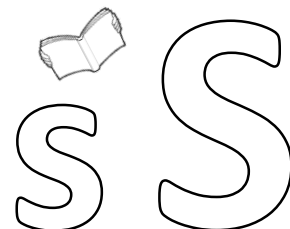

Escreve.

s
S

sa se si so su

Sa Se Si So Su

sabão seta sino sopa sumo

Circunda os *s* *S*

sapato	Lónia	saia	saco	sair	seda
sapo	sapudo	selo	sítio	Palomé	sopa
Pá	sala	soco	seu	sacola	sino
sumo	sineta	seta	soca	saiote	sua

Assinala com X as figuras em cujos nomes ouves **s**.

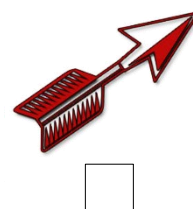
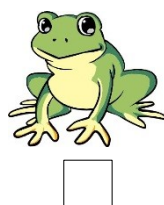
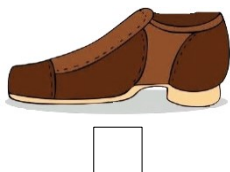
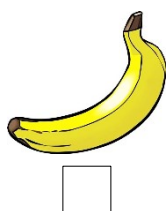

 Faz a correspondência e completa.

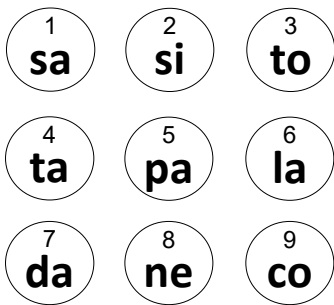

1 sa	5 pa	3 to	
2	8	4	
1	6	7	
1	9	6	

 Escreve os seus nomes:



saia

sapato

sumo

sineta



sapo

saco

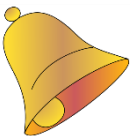

 Escreve as frases completas:

O  caiu no  do Simão.

A Sónia ouve o  na .



O sapo pulou do saco.

O sapo nadou no regato.

A Salomé viu o sapo no regato.

Nome : _____

INFORMAÇÃO : _____

Data : ____ / ____ / ____

COLORIR.

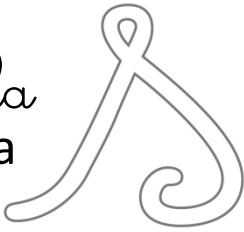
sacola
sacola

s s

sa sa

se se

si si

so so

su su



Lê, copia e ilustra.

O sino da capela toca.
A saia da Ana é nova. O sapo
pula muito. O Sá sai da sala de
aula. O Simão leva a sacola.



Forma frases.



selo



saia

Nome : _____

INFORMAÇÃO : _____

Data : ____ / ____ / ____

COLORIR.

Sónia

S



suma

S

S

Sa

Se

Si

So

Su

S

Sa

Se

Si

So

Su

 Lê e copia.

O Sá ouviu o sino.
 Ele sai da sala de aula e leva a sacola.
 No pátio viu a Sónia e o Simão.
 A Sónia levava uma saia de seda.
 Ele comeu sopa, ovo e uma salada.

 Completa.

O Sá ouviu o _____.

No pátio viu a _____ e o _____.

A Sónia levava uma _____ de _____.

O Sá comeu _____, _____ e uma _____.

Nome : _____

INFORMAÇÃO : _____

Data : ____ / ____ / ____



A **S**alomé bebe o **s**umo de limão.

 Escreve as frases completas.

 É a sola do  da  .

 A  é de lã.

 O  saiu da toca.

 A  come muita  .

 Ordena as palavras e escreve a frase.

 Beto a O sacola. leva _____ selo. o cola A Sofia _____

Nome : _____

INFORMAÇÃO : _____

Data : ____ / ____ / ____



Escreve as frases completas.

É o **S**imão.

O



é do



.

A Sónia leva o

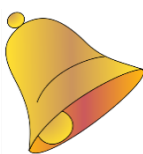

no



.

O pai vê o

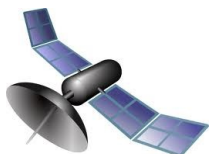

pelo binóculo.

O



vê o



na



.

A Simone come a



e bebe o



.



Ordena as palavras e escreve a frase.

pegou sapato. no Ana A

sino. toca o Nuno O

Nome : _____

INFORMAÇÃO : _____

Data : ____ / ____ / ____



Inventa uma frase para cada gravura.

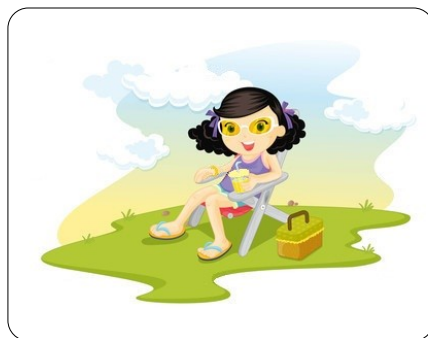
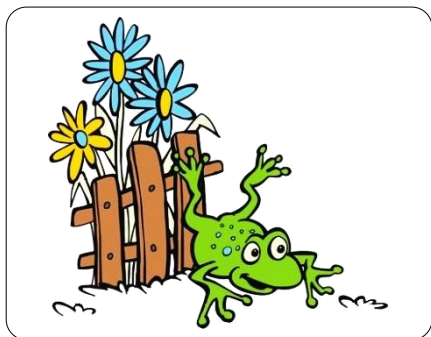

Nome : _____

INFORMAÇÃO :

Data : ____ / ____ / ____



Escreve as palavras que correspondem às imagens. Pinta.

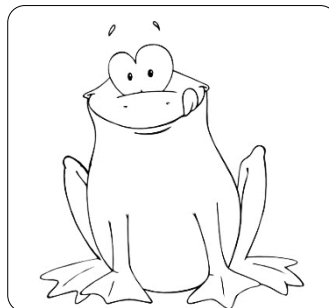
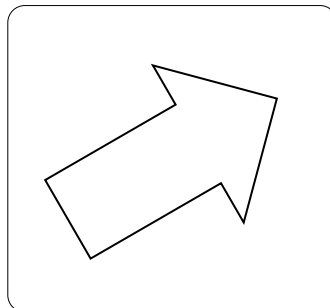
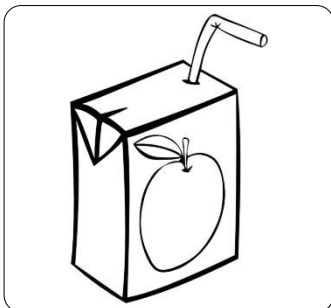
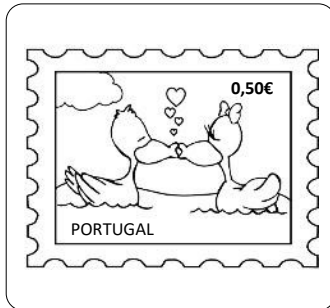
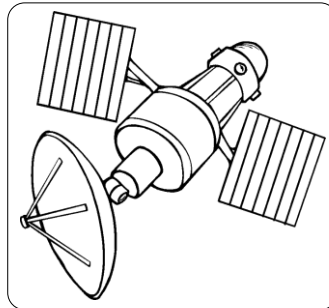
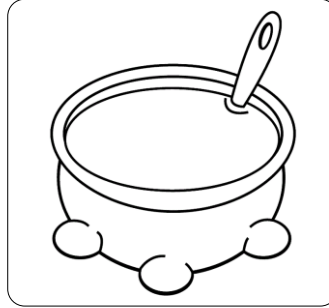

sapo
sapato

saia

selo

sopa

sino

sumo

seta

salada

satélite

Sónia

sete

Nome : _____

INFORMAÇÃO :

Data : ____ / ____ / ____



Lê as palavras. Escreve a que está de acordo com a figura.

sineta **ou** sapato?



É a _____.

seta **ou** sala?



É a _____.

sacola **ou** salada?

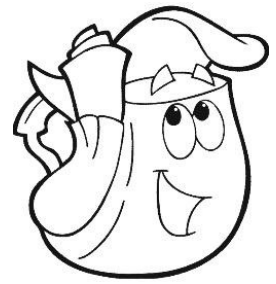

É a _____.



Lê as palavras e faz os desenhos.

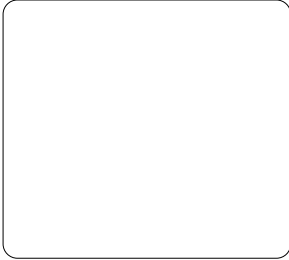

sete

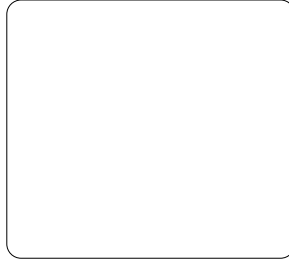

Salomé

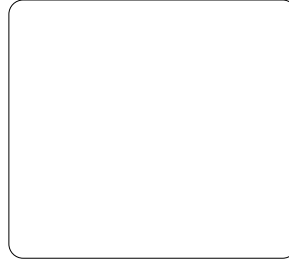

satélite

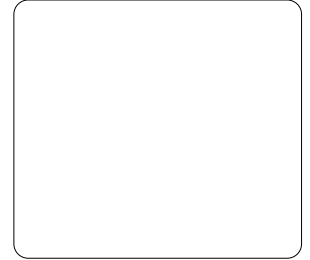

salada



seta



sumo



sino



sopa



selo

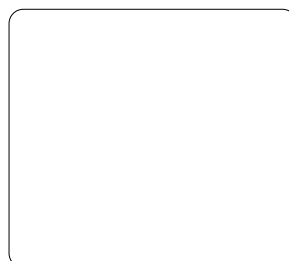

saia



sapato



sapo

Nome : _____

INFORMAÇÃO : _____

Data : ____ / ____ / ____



Junta as sílabas e forma a palavra que está de acordo com a imagem.

<p>po</p> <p>sa</p>  <p>_____</p>	<p>pa</p> <p>sa</p> <p>to</p>  <p>_____</p>
<p>su</p> <p>mo</p>  <p>_____</p>	<p>mo</p> <p>Si</p> <p>ne</p>  <p>_____</p>
<p>pa</p> <p>so</p>  <p>_____</p>	<p>da</p> <p>la</p> <p>sa</p>  <p>_____</p>
<p>so</p> <p>ca</p>  <p>_____</p>	<p>té</p> <p>te</p>  <p>li</p> <p>sa</p> <p>_____</p>

Nome : _____

INFORMAÇÃO : _____

Data : ____ / ____ / ____



Descobre palavras com **sa, se, si, so, su.**



A crossword puzzle grid with various icons placed around it. The icons include: a girl with a pink hat, a glass of orange juice with a straw and lemon slice, a green frog, a red high-heeled shoe, a bowl of colorful cereal, a blue bird, a yellow hat, a yellow bell, a green bag, a pink dress, a golden horn, a red gift bag, a blue cup of coffee, and a blue number 7.

Escreve as palavras que descobriste.





Nome : _____

INFORMAÇÃO : _____

Data : ___/___/___



Lê e escreve este pequeno texto.
Pinta o desenho a teu gosto.

A Sofia sujou-se

Toca a sineta da aula.
A Sofia saiu e caiu. Sujou-se toda.
A sua colega Sónia ajudou-a.
Sacode a saia e o saco.
Lava o sapato da sua amiga.



