

j

J



janela

j

J



j

J



jibóia

j

J



j J



janela

j J

j J

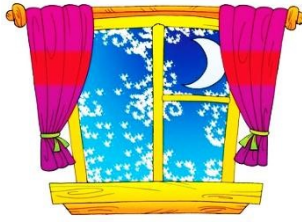

janela

j J

j J

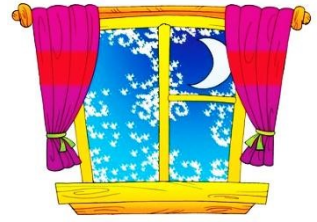

janela

j J

j J

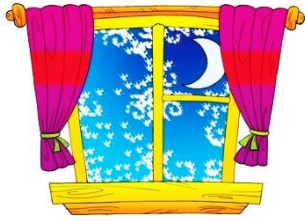

janela

j J

j J

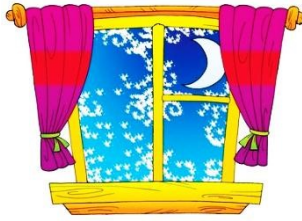

janela

j J

j J



janela

j J

j J



janela

j J

j J



janela

j J

j J



janela

j J

j j



j jibóia j

j j



j jibóia j

j j



j jibóia j

j j



j jibóia j

j j



j jibóia j

j j



j jibóia j

j j



j jibóia j

j j



j jibóia j

j j



j jibóia j



javalí



javalí



javalí



javalí



javalí



javalí



javalí



javalí



javalí



javalí



javalí



javalí



javalí



javalí



javalí





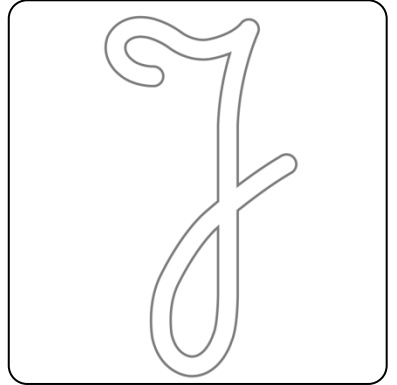
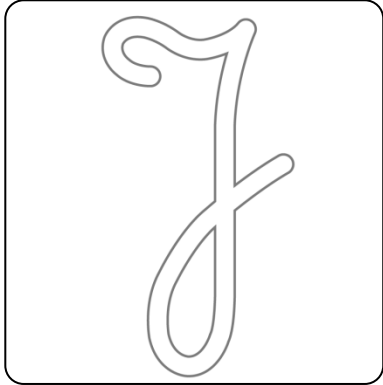
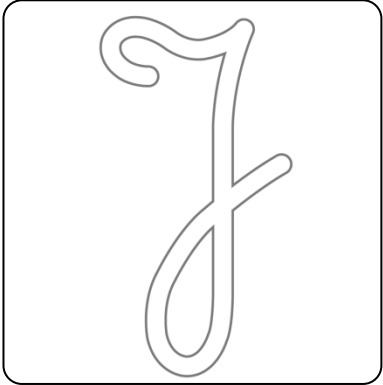
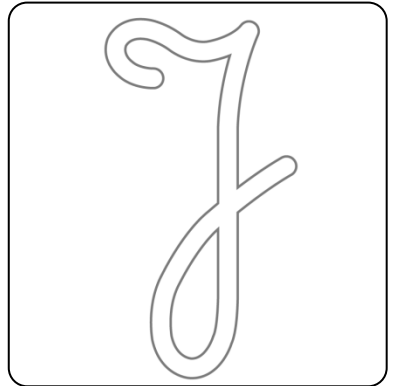
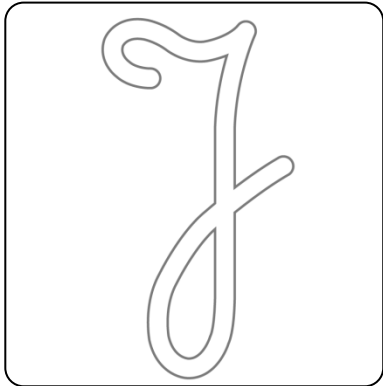
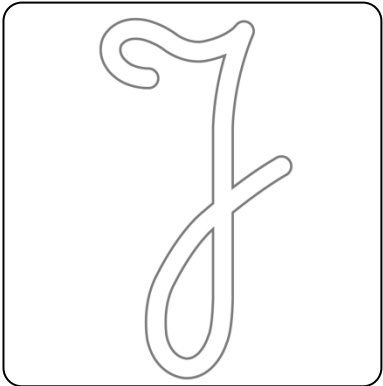
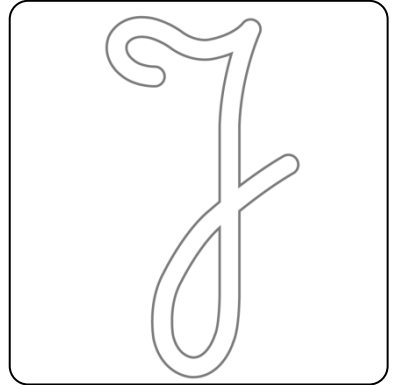
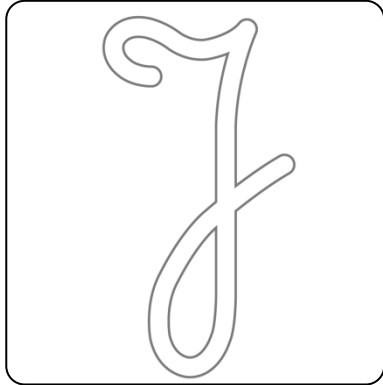
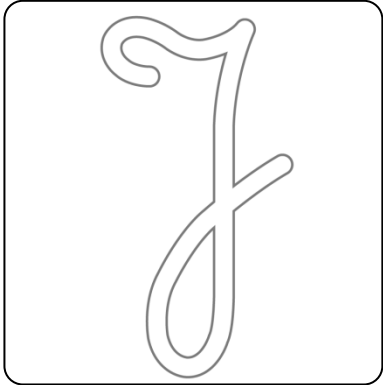
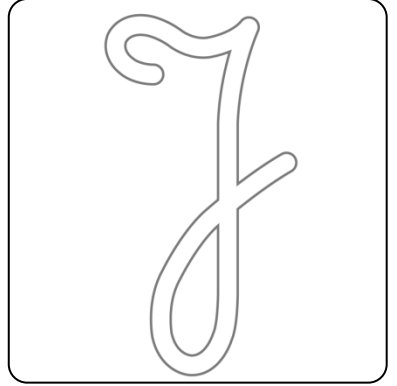
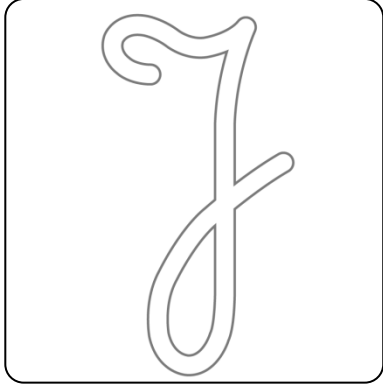
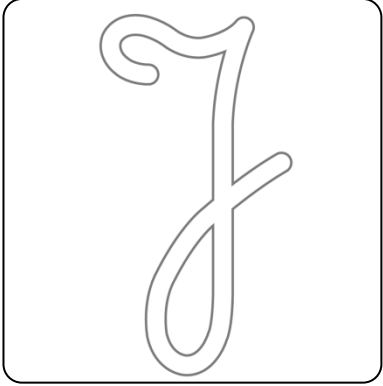
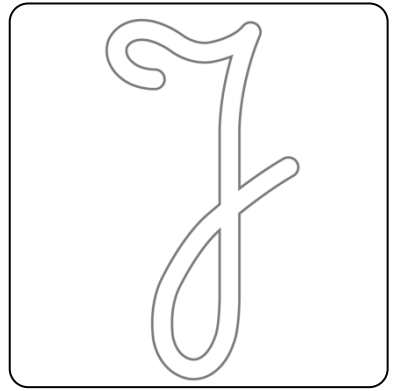
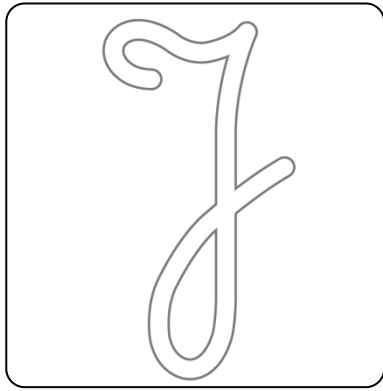
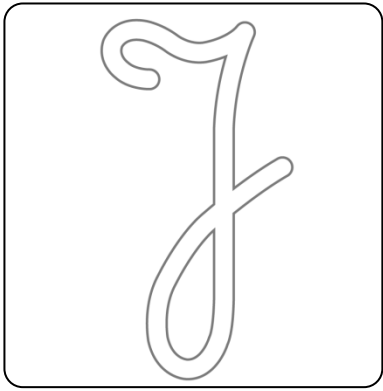



**JANELA**

**LAJE**

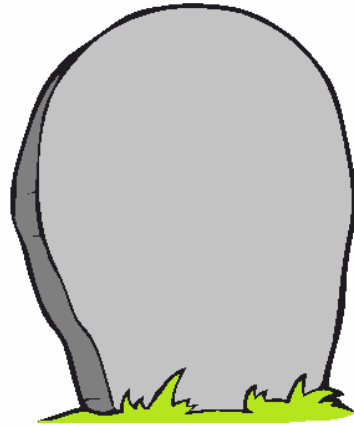

**JIPE**

**JOGO**



**JUBA**





# A história do *Jibóia encantada*



O João, o Joca e a Júlia foram passar férias a uma floresta de África. O João jogava Judo com a Júlia e o Joca ficava em casa a ajudar a mãe.

Um dia, da sua janela, o Joca viu uma enorme jibóia numa laje perto do jipe do pai. Ficou assustado e chamou:

– Mãe, mãe, vem cá! Uma jibóia vai entrar no jipe.

Cheio de coragem, saiu de casa e foi chamar o João e a Júlia que estavam lá foram, perto da jibóia. Mal se aproximou deles, ouviu uma voz estranha:

– Não tenhas medo! Eu sou uma princesa encantada de jibóia e apenas quero brincar.

Era a jibóia que falava. Joca ficou espantado e perguntou-lhe:

– Mas tu não fazes mal a ninguém?

– Não, já te disse. Eu só quero brincar – disse ela.

– Então, está bem. Queres jogar judo? Dá um salto inclinado para cima. Agora cai direitinha neste buraco. Dá outro salto em curva para cima para saíres do buraco. Depois estica a tua cauda... – explicou Joca.

– Isto é um belo exercício – dizia a jibóia, enquanto saltava.

– Estás a ver? Já sabes fazer o “j” de jibóia – disse o Joca, enquanto lhe dava um beijo na cabeça.

Ao sentir o beijo, o encanto desapareceu e a jibóia transformou-se numa linda princesa.

Nome : \_\_\_\_\_

INFORMAÇÃO :

Data : \_\_\_/\_\_\_/\_\_\_



Copia.

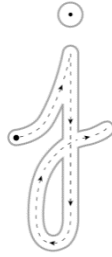

j  
j  
j  
j  
j

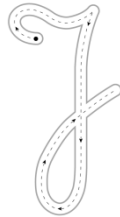

J  
J  
J  
J  
J  
J  
J

j J jibóia  
j J jibóia

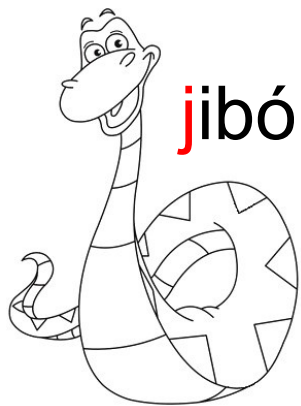

ja Ja  
je Je  
ji Ji  
jo Jo  
ju Ju

j J jibóia  
j J jibóia

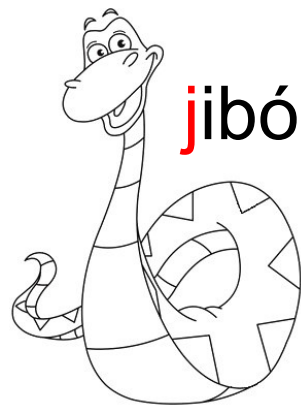

ja Ja  
je Je  
ji Ji  
jo Jo  
ju Ju

j J jibóia  
j J jibóia

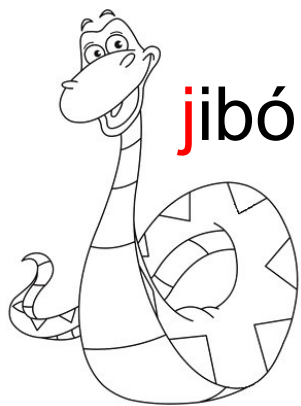

ja Ja  
je Je  
ji Ji  
jo Jo  
ju Ju

j J jibóia  
j J jibóia

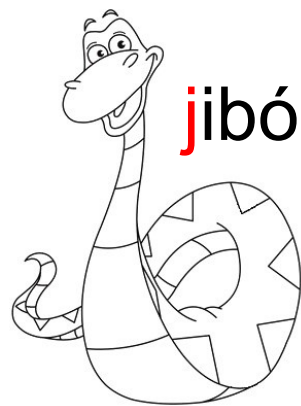

ja Ja  
je Je  
ji Ji  
jo Jo  
ju Ju

Nome : \_\_\_\_\_

INFORMAÇÃO :

Data : \_\_/\_\_/\_\_

\_\_\_\_\_











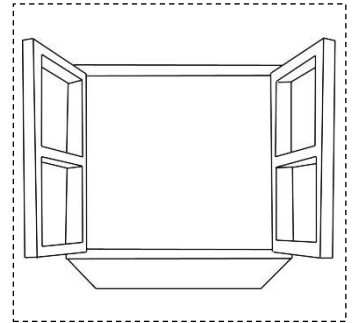
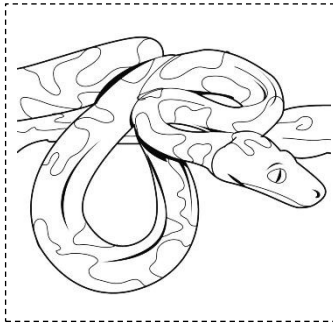
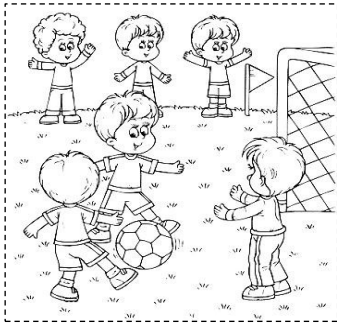
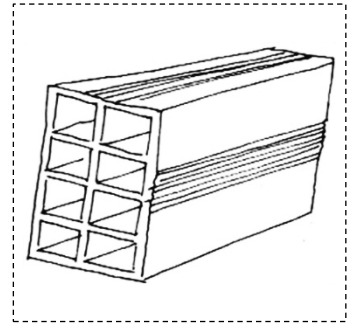
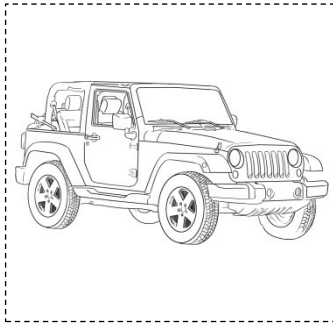
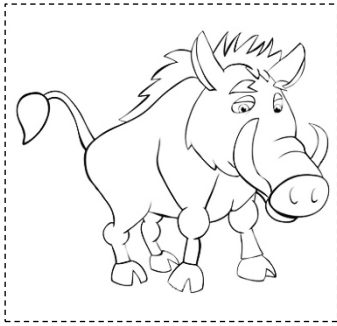
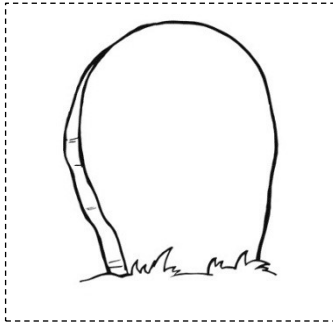

Pinta e recorta as imagens e as palavras. Depois cola-as correctamente na folha anterior.



**janela**

**javali**

**jibóia**

**judo**

**jogo**

**pijama**

**tijolo**

**laje**

**jipe**

*jogo*

*janela*

*judo*

*jibóia*

*tijolo*

*javali*

*jipe*

*pijama*

*laje*

Nome : \_\_\_\_\_

INFORMAÇÃO : \_\_\_\_\_

Data : \_\_/\_\_/\_\_



Cola os desenhos da página seguinte junto às frases que lhe correspondem. Cola a seguir as palavras, formando novamente a frase.

**É o jogo de volei.**

**O pijama do Jaime é bonito.**

**A jibóia é muito má.**

**A Joana vai no jipe.**

**O Joca põe o tijolo.**



Ordena as frases. Corta os desenhos e todas as palavras das frases que ordenaste. Cola-as na página anterior.

pijama O Jaime é do bonito.

volei. de jogo É o

vai A jipe. no Joana

Joca O tijolo. o pão

jibóia A muito é má

