

r

R

rei



r

R



r

R



rato

r

R



r R



rei

r R

r R



rei

r R

r R



rei

r R

r R



rei

r R

r R



rei

r R

r R



rei

r R

r R



rei

r R

r R



rei

r R

r R



rei

r R

r R



r R

r R



r R

r R



r R

r R



r R

r R



r R

r R



r R

r R



r R

r R



r R

r R



r R

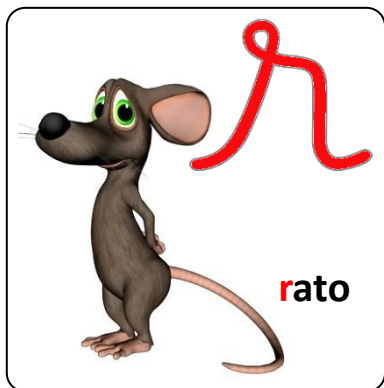
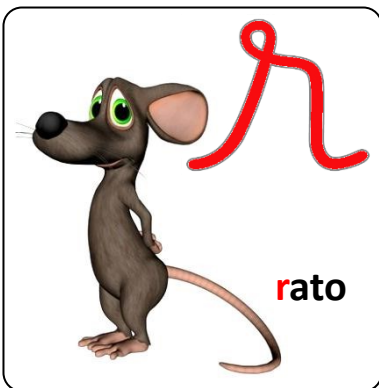
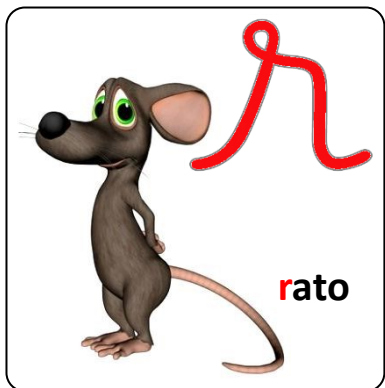
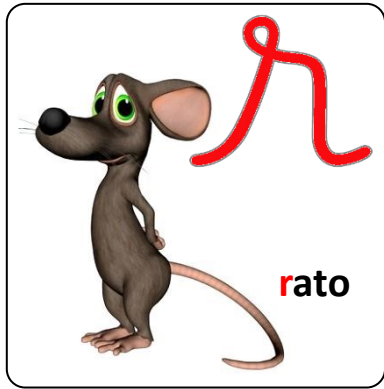
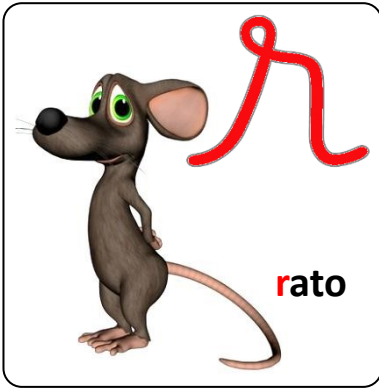
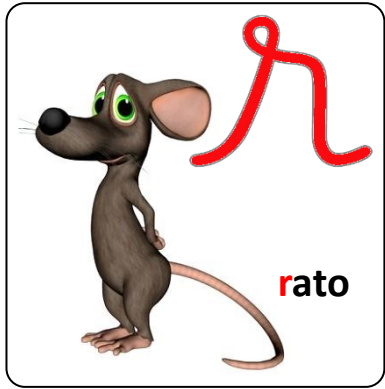
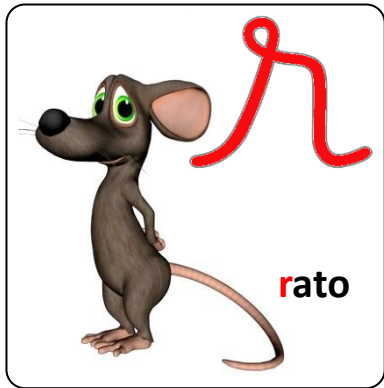
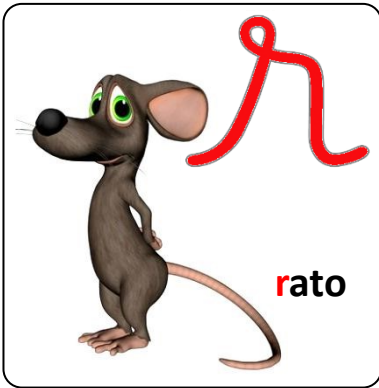
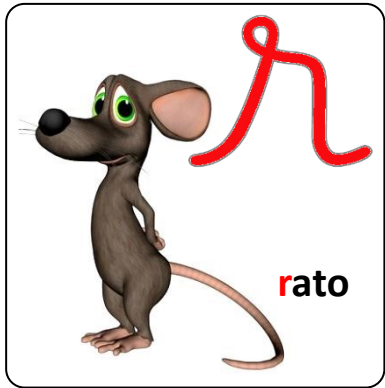
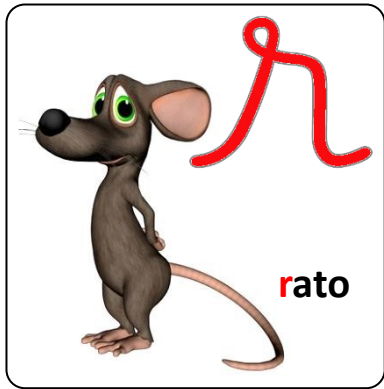
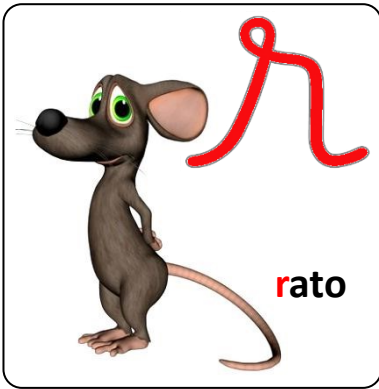
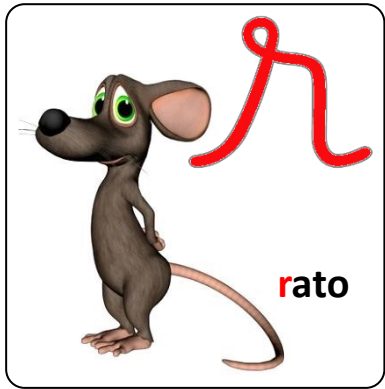
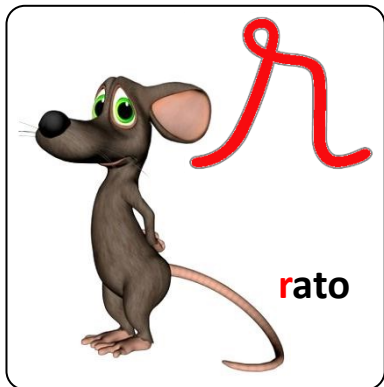
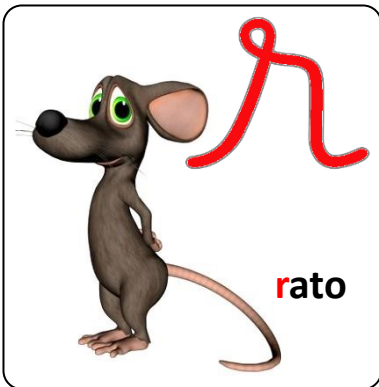
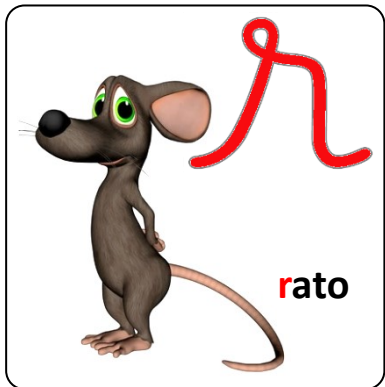



RATO

REMO



RIO

RODA



RUA





A história do

O ratinho perde a namorada

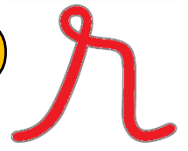

A Rita mora à beira do rio Ave. Muitas vezes vai para junto da água conversar com as suas amigas rãs, com as relas, que são primas das rãs, e com os peixinhos.

Naquele dia, apareceu-lhe uma rela que disse:

– Ritinha, ando muito preocupada com o meu amigo rato. Ele está muito triste.

– Que lhe aconteceu? – perguntou a Rita.

– Não sei. O melhor é chamá-lo para lhe perguntar.

O rato apareceu e a Rita interrogou-o:

– Que tens, lindo ratinho?

– Estou muito triste. Não encontro a minha namorada, a ratinha Róiroi – respondeu o rato.

– Vamos procurá-la em terra. Anda daí! – disse a Rita.

O rato saltou para terra, não viu a sua amada e, desesperado, roeu a roda do camião do avô da Rita.

– A ratinha Róiroi não está aí! E não roas a roda do camião do meu avô!

A certa altura, dum buraco cavado na terra, saiu a ratinha Róiroi. Foi uma alegria! Os dois ratinhos abraçaram-se e beijaram-se ternamente.

Nome : _____

INFORMAÇÃO : _____

Data : __/__/__

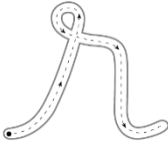

r

r

r

r

r

r

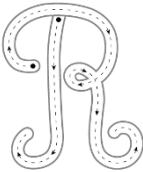

R

R

R

R

R

R

r R

r R

rei



ra

Ra

re

Re

ri

Ri

ro

Ro

ru

Ru

r R

r R

rei



ra

Ra

re

Re

ri

Ri

ro

Ro

ru

Ru

r R

r R

rei



ra

Ra

re

Re

ri

Ri

ro

Ro

ru

Ru

r R

r R

rei



ra

Ra

re

Re

ri

Ri

ro

Ro

ru

Ru

Nome : _____

INFORMAÇÃO :

Data : __/__/__



Pinta e recorta as imagens e as palavras. Depois cola-as correctamente na folha anterior.

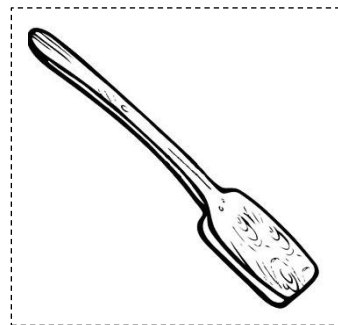
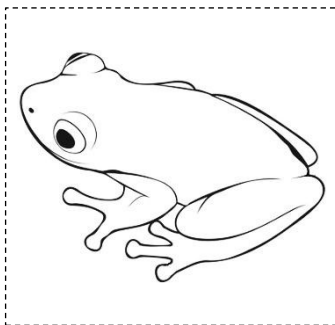
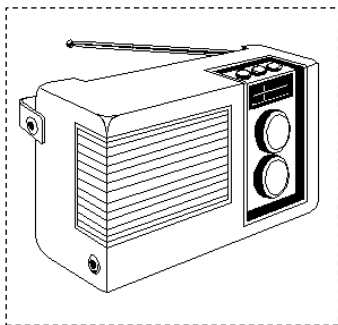
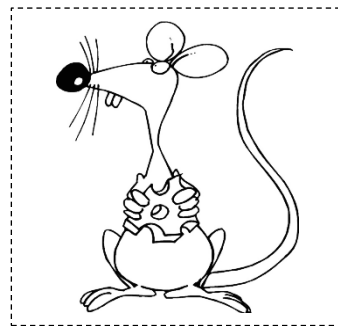
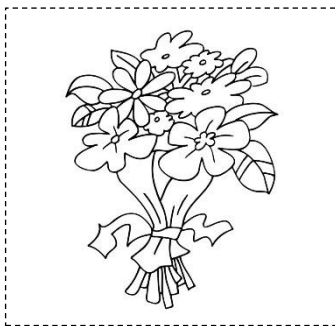
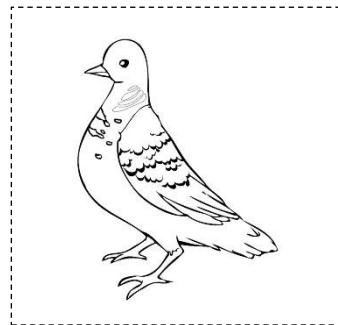
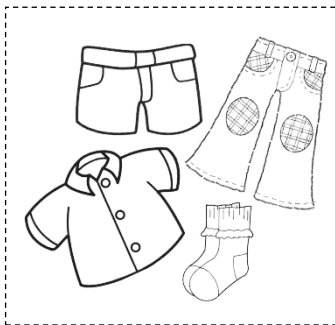
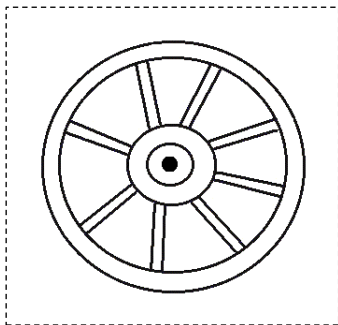

roupa

rola

rei

remo

roda

ramo

rã

rato

rádio

rei

roupa

ramo

roda

rádio

rato

rola

remo

rã

Nome : _____

INFORMAÇÃO : _____

Data : __/__/__

**Com os rectângulos da folha seguinte, completa os desenhos e as palavras.
Pinta a teu gosto e copia.**

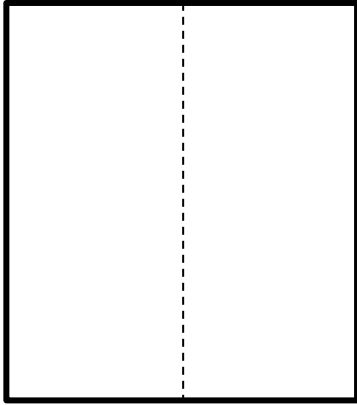

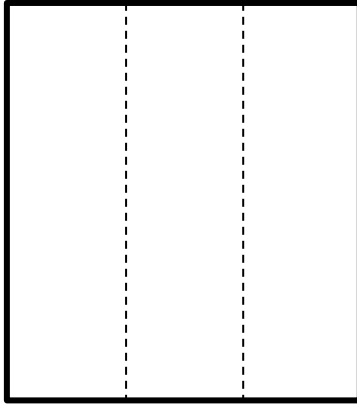

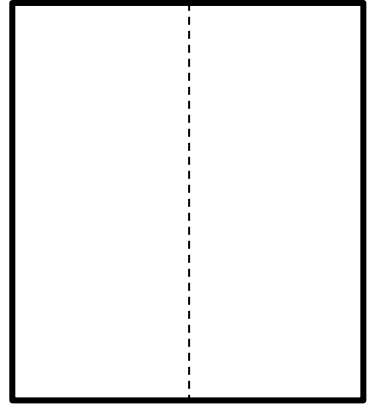

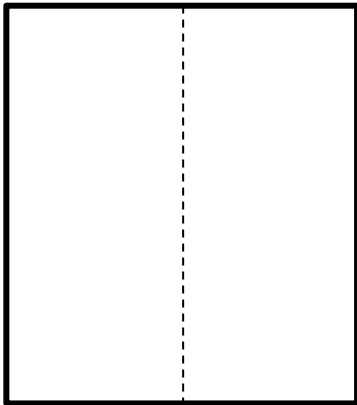

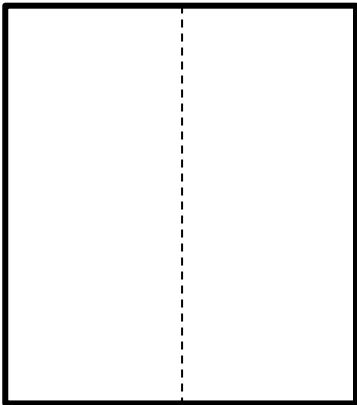

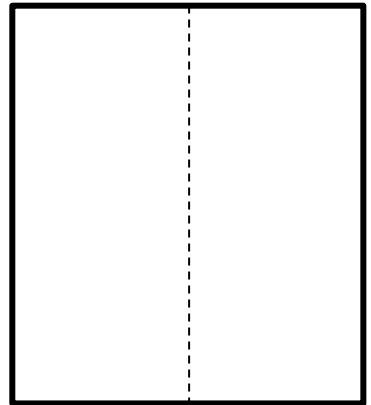

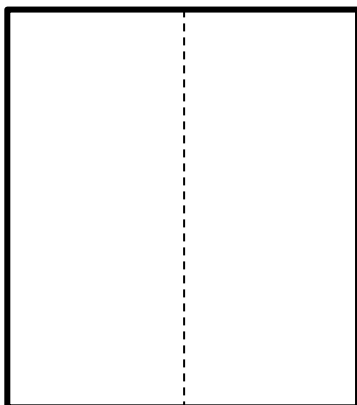

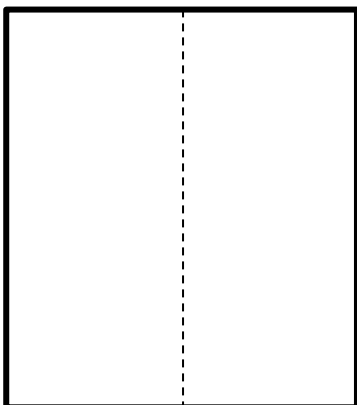

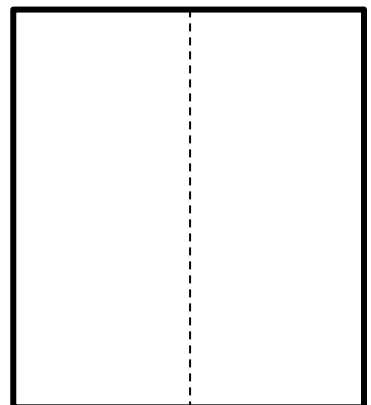



Recorta os rectângulos e junta-os correctamente na folha anterior.

