

t

T

tio



t

T



t

T

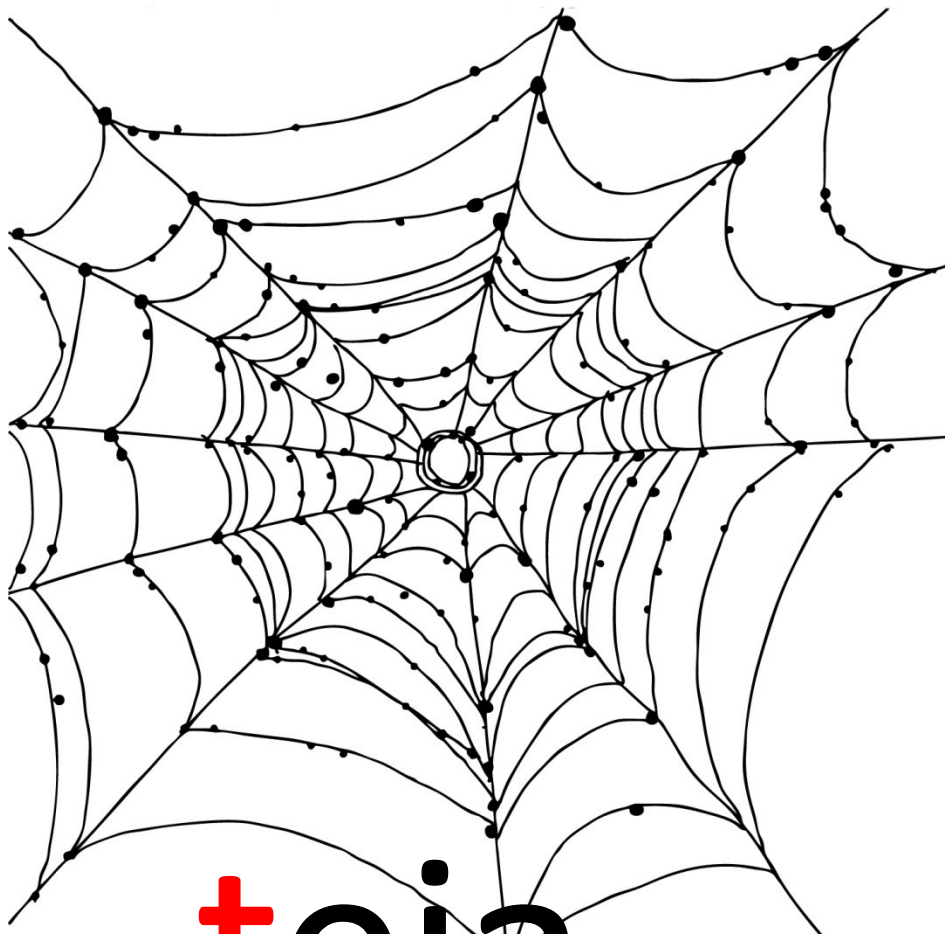

teia

t

T



t T

tio



t T

t T

tio

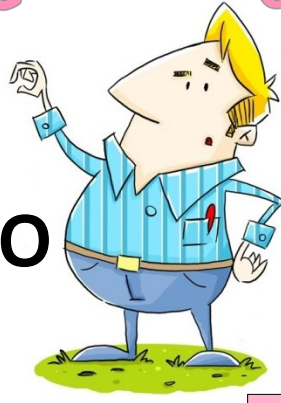

t T

t T

tio

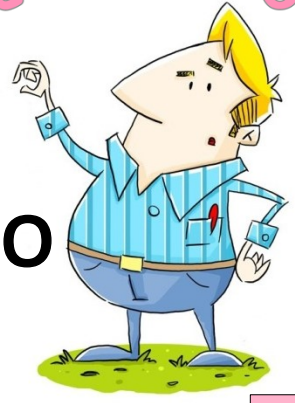

t T

t T

tio



t T

t T

tio



t T

t T

tio

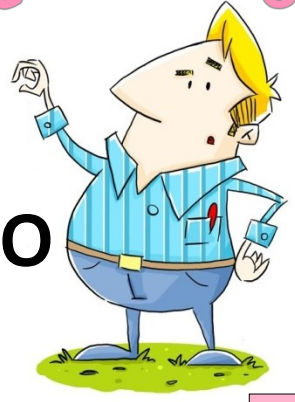

t T

t T

tio



t T

t T

tio



t T

t T

tio



t T

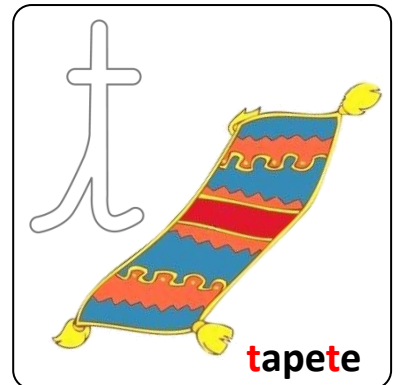
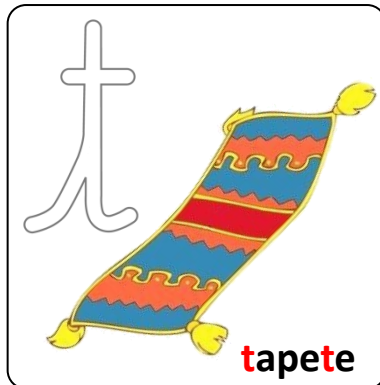
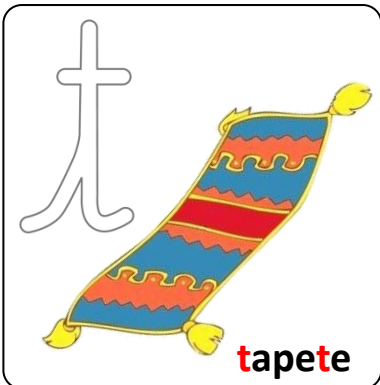
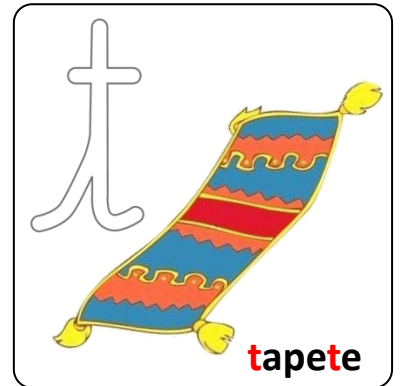
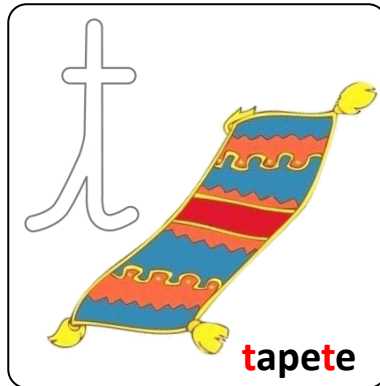
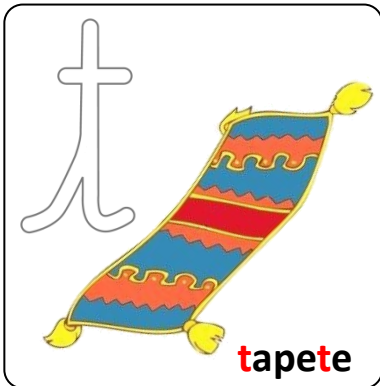
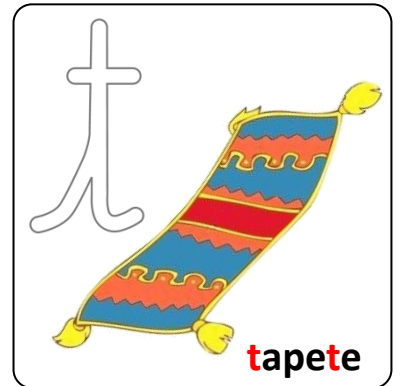
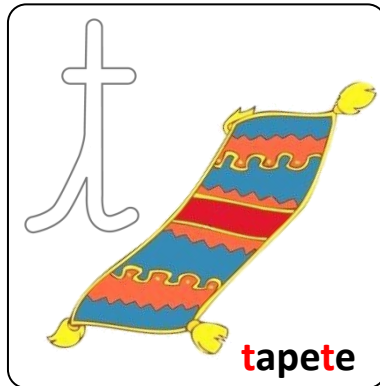
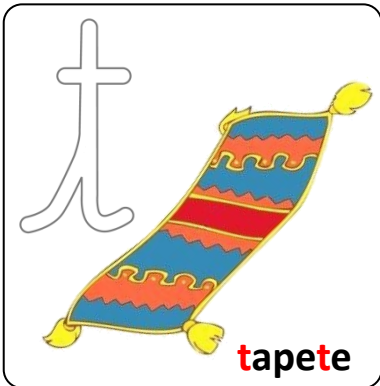
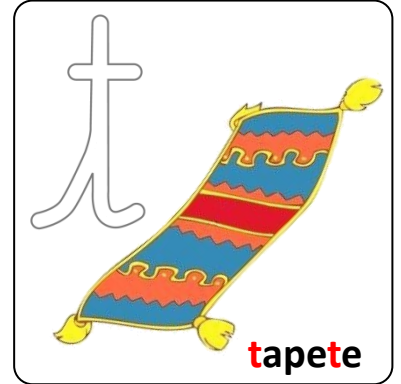
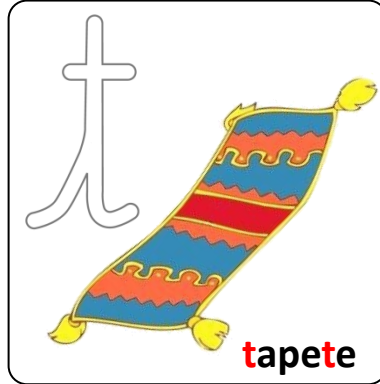
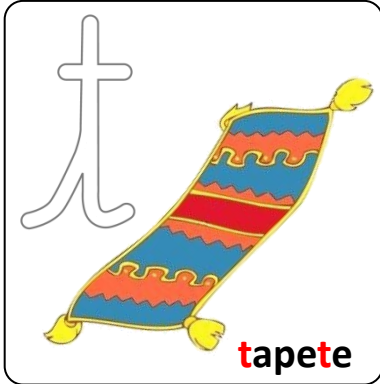
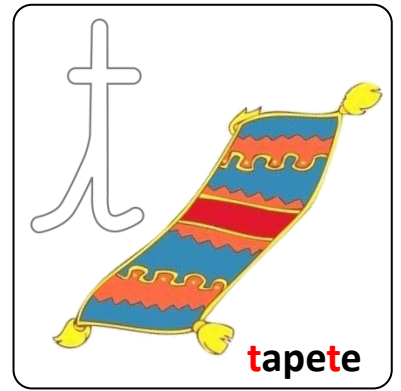
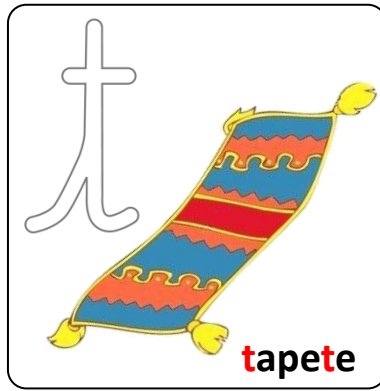
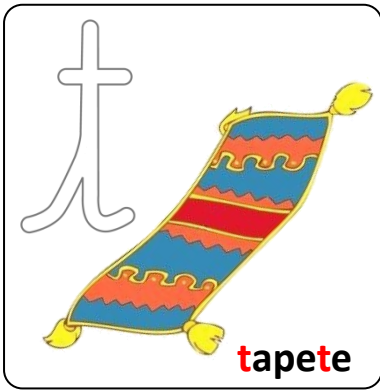

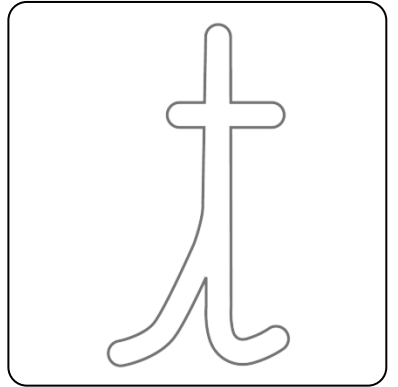
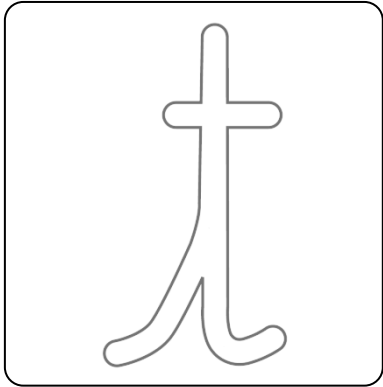
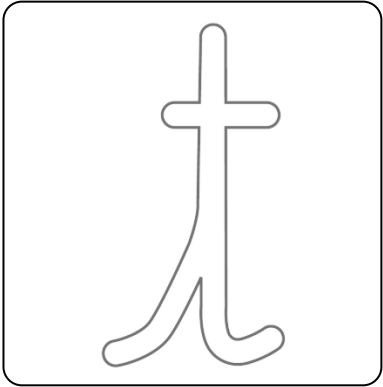
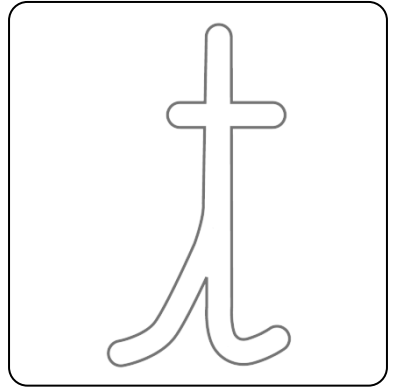
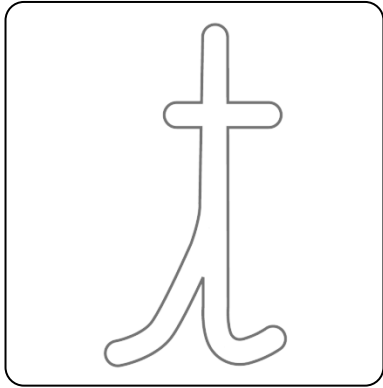
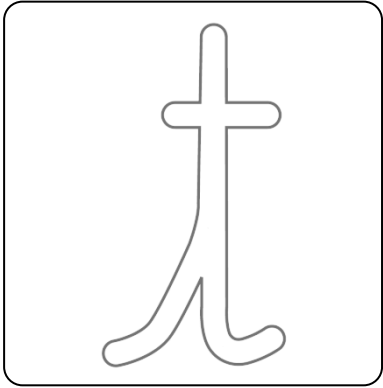
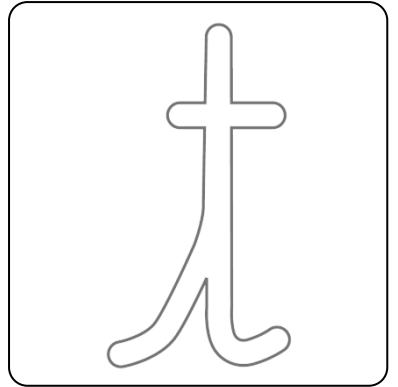
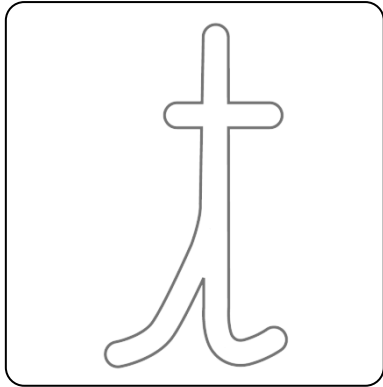
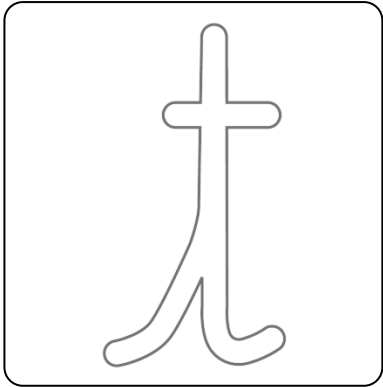
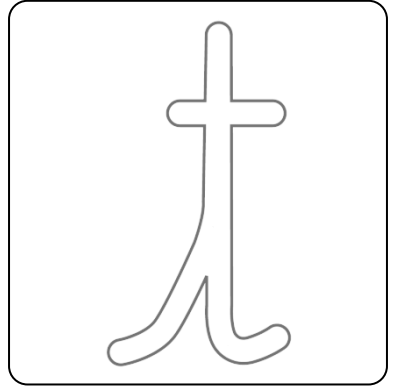
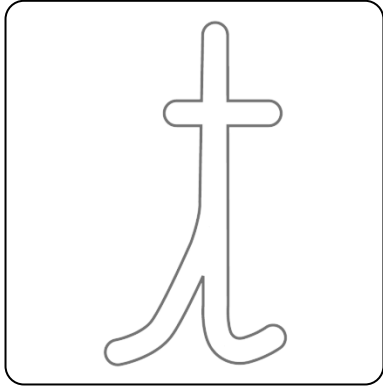
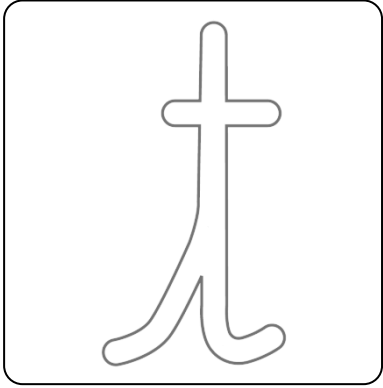
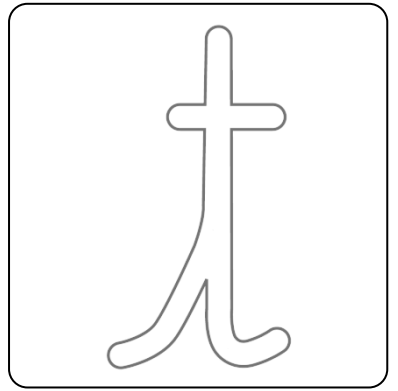
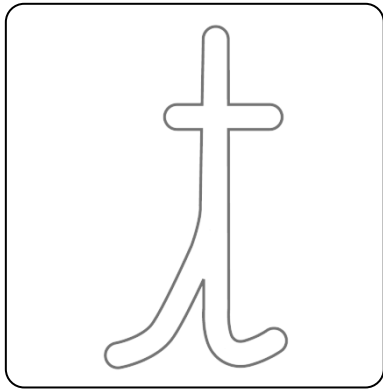
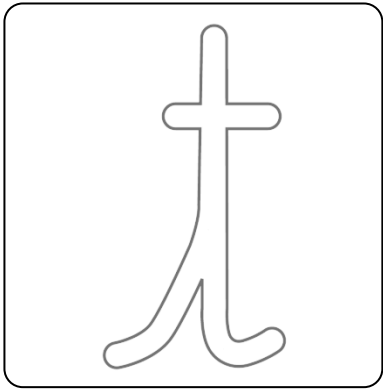



A história do

Um tio tocador de corneta



A Tutu e o tio estavam a brincar na sala. A Tutu era uma menina de seis anos que tinha um lindo tóto na cabeça. O tio, já velhinho, parecia ainda novo. Estava muito divertido, saltava e tocava corneta.

– Tá, tá, tá, tá, tá! Té, té, té, té, té, té!

A Tutu ouvia e ria-se com o espetáculo que o tio apresentava.

– Tio, és tão tonto! - exclamou a Tutu, com carinho.

– Mas tu gostas assim, não gostas? Então deixa-me ser tonto à vontade - afirmou o tio.

– Mas, tio, eu tenho de trabalhar. Por isso, para lá com as tuas brincadeiras e ajuda-me a fazer o “t” de tio – pediu a menina.

– Está bem, eu ajudo-te. É fácil! Salta bem para cima! Deixa-te cair pelo mesmo sítio da subida. Já perto do chão, estica a perninha para não caíres. No cimo da letra, põe um travessão.

– Que bom! Amanhã, a minha professora vai ficar feliz. Já sei fazer o “t”! - exclamou Tutu.

– Agora já posso tocar à vontade? - perguntou o tio.

– Podes tocar toda a noite. Eu vou fazer “montes” de “t” de tio - disse Tutu.

Nome : _____

INFORMAÇÃO :

Data : __/__/__



t

t

t

t

t

t

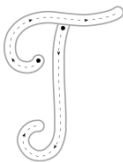

T

T

T

T

T

T

t T

pote



t T

ta

Ta

te

Te

ti

Ti

to

To

tu

Tu

t T

pote



t T

ta

Ta

te

Te

ti

Ti

to

To

tu

Tu

t T

pote



t T

ta

Ta

te

Te

ti

Ti

to

To

tu

Tu

t T

pote



t T

ta

Ta

te

Te

ti

Ti

to

To

tu

Tu

1º
ANO

PORTUGUÊS

RUBRICA :

Nome : _____

INFORMAÇÃO :

Data : __/__/__



Pinta e recorta as imagens e as palavras. Depois cola-as correctamente na folha anterior.

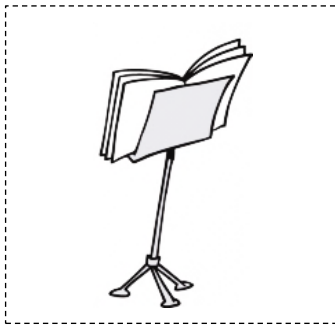
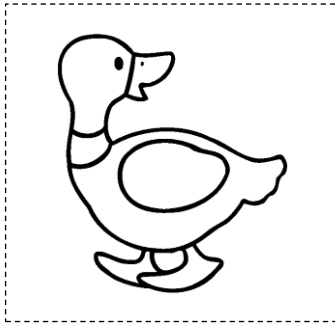
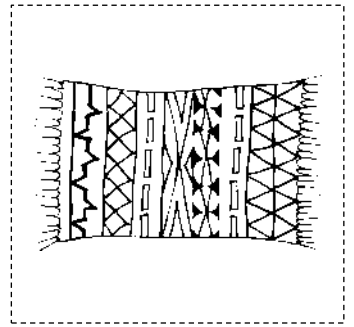
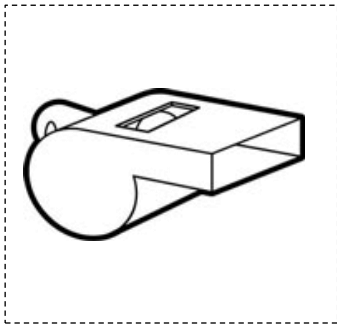

tapete

apito

pote

pato

pata

pauta

tia

tio

oito

tio

pata

tia

pauta

pote

tapete

apito

oito

pato